

TOA CEILING MOUNT SPEAKER 6INCH 6W PC-2360EN

The PC-1860EN is certified according to the European Standard EN 54-24:2008, DoP number is 19-010.

DESCRIPTION

The PC-2360EN is the voice alarm certification product. The PC-2360EN is suitable for announcement and BGM system use in high quality sound cone speaker. Speaker design that harmonize with the venue's architecture and decor. Thin panel does not clash with interior design.

SPECIFICATIONS

Rated Input	6 W (100 V line), 3 W (70 V line)
Rated Impedance	100 V line: 1.7 k Ω (6 W), 3.3 k Ω (3 W), 6.7 k Ω (1.5 W), 13 k Ω (0.8 W) 70 V line: 1.7 k Ω (3 W), 3.3 k Ω (1.5 W), 6.7 k Ω (0.8 W), 13 k Ω (0.4 W)
Sensitivity	94 dB (1 W, 1 m) (500 Hz - 5 kHz, pink noise) 92 dB (1 W, 1 m) (100 Hz - 10 kHz, pink noise) 80 dB (1 W, 4 m) (100 Hz - 10 kHz, pink noise)
Maximum Sound Pressure Level	99 dB (6 W, 1 m) (100 Hz - 10 kHz, pink noise) 87 dB (6 W, 4 m) (100 Hz - 10 kHz, pink noise)
Frequency Response	60 Hz - 20 kHz (peak -20 dB)
Coverage Angle (-6 dB)	Horizontal and Vertical: 160° (500 Hz), 170° (1 kHz), 160° (2 kHz), 60° (4 kHz) according to EN 54-24
Environmental type	A (indoor applications)
Speaker Component	16 cm (6") cone-type
Operating Temperature	-10 °C to +50 °C (14 °F to 122 °F)
Dimensions for Fixing Hole	Mounting hole: $\phi 200 \pm 3$ mm (7.87" \pm 0.12") Ceiling thickness: 5 - 25 mm (0.2" - 0.98")
Speaker Mounting Method	Spring clamp
Applicable Cable	Solid wire: 0.5 - 3 mm ² (AWG 20 - 12)
Connection	Push wire connection (Bridging terminal-2 branch type)
Finish	Frame: Steel plate, white (RAL 9016 equivalent), paint Grille: Steel net, white (RAL 9016 equivalent), paint
Dimensions	$\phi 230 \times 76$ (D) mm (9.06" \times 2.99")
Weight	740 g (1.63 lb)
Accessory	Paper pattern $\cdots 1$, Zip tie $\cdots 3$

APPEARANCE

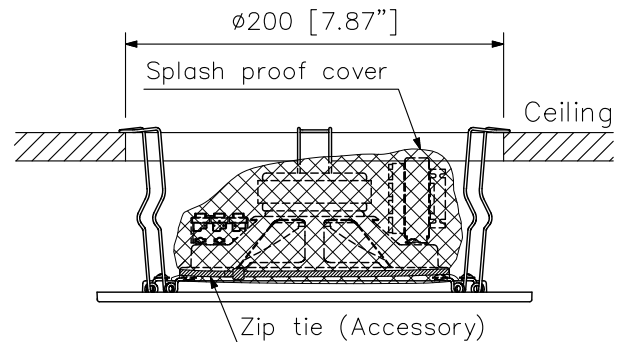
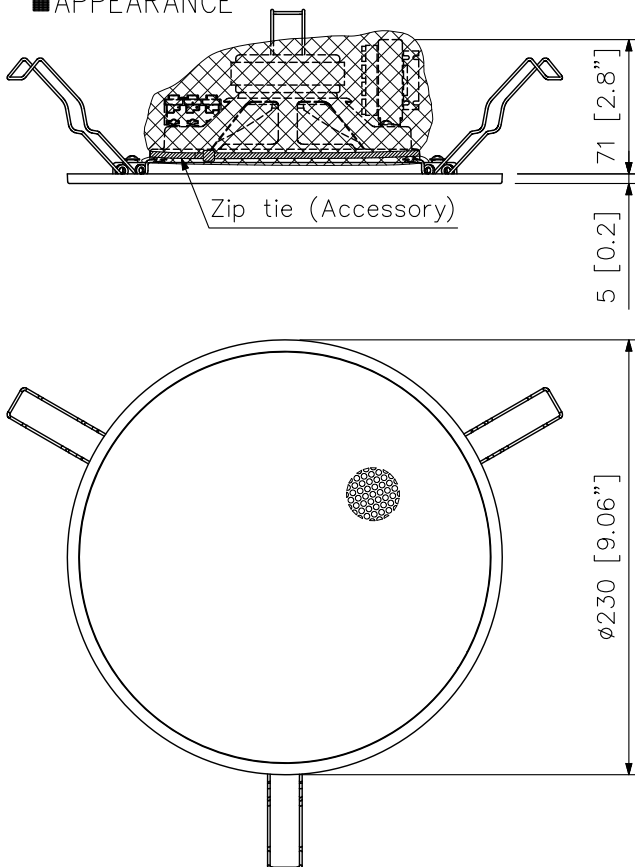

Mounting Diagram

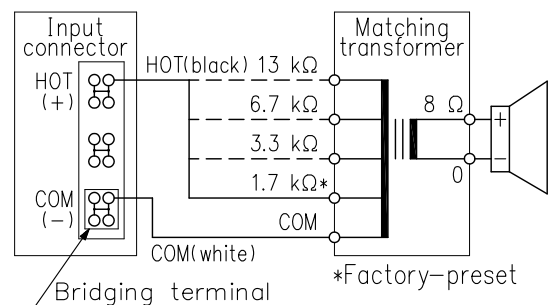

Wiring Diagram

Note: Use transformer terminals when changing input impedance.

UNIT: mm SCALE: 1/4