

■ DESCRIPTION

The BP-900A is a rechargeable lithium-ion battery designed for exclusive use with the conference units TS-821, TS-822, TS-921, and TS-922.

■ SPECIFICATIONS

Nominal Voltage	7.2 V DC
Operating Temperature	0 °C to +40 °C (32 °F to 104 °F)
Operating Humidity	90 %RH or less (no condensation)
Dimensions	71.6 (W) × 20.5 (H) × 37.5 (D) mm (2.82" × 0.81" × 1.48")
Weight	95 g (0.21 lb)

■ APPEARANCE

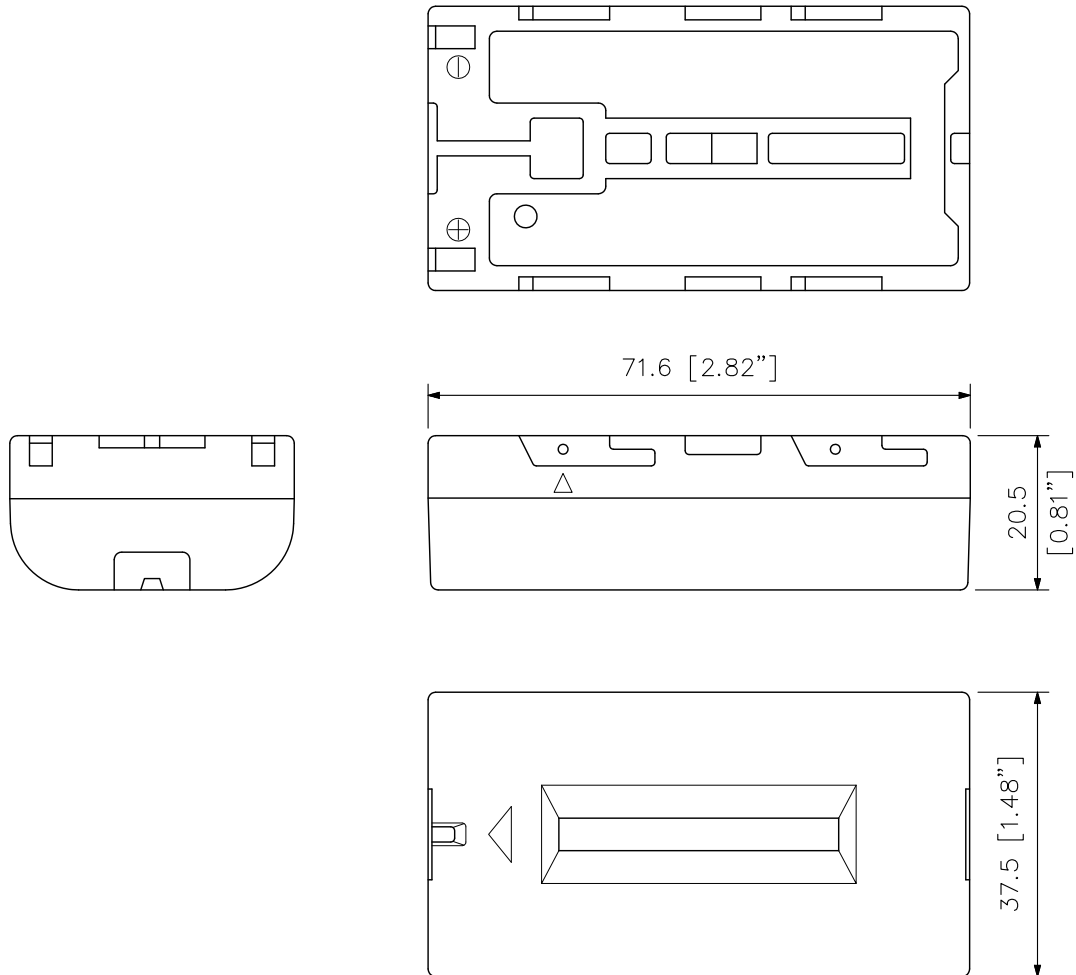

Note: Be sure to fully charge the battery before use.
 Be sure to use the BC-900 or BC-920 charger with an exclusive charging function (option) when recharging the batteries.

UNIT: mm SCALE: 1/1